

Section 15

Folded Hybrid and Magic Tees and Transducers

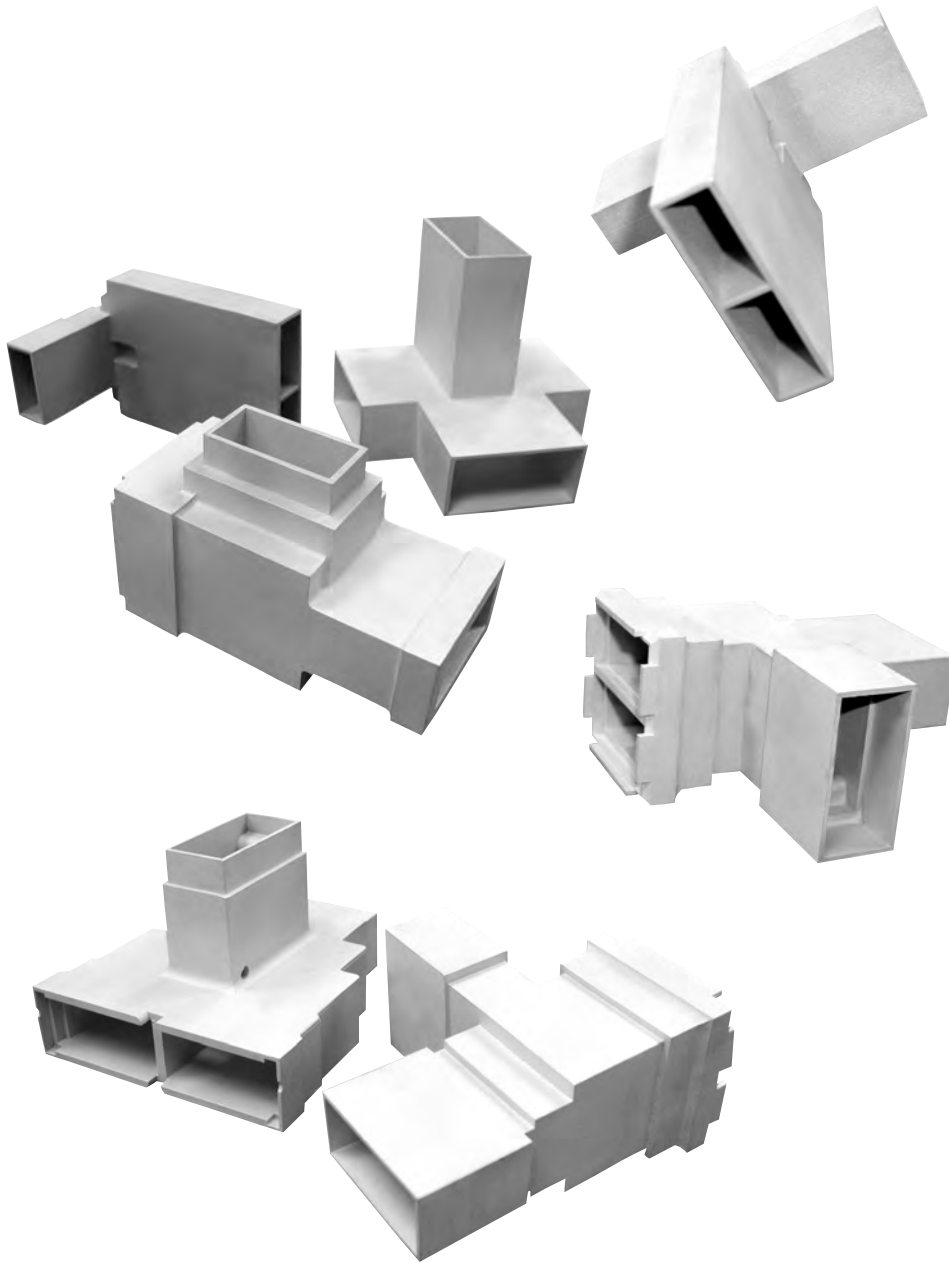

Theory

Each MDL folded hybrid tee is completely tested for VSWR characteristics of the E and H arms, for power split feeding the same arms, and for isolation between the E & H arms. The isolation between parallel arms is not measured but the figures given in the catalog are guaranteed. In most cases the guarantee is based on the lowest theoretical isolation, which is a function of the match of the E and H arms. In the few cases where our guarantee exceeds the theoretically worst figures, measurements have been made on a sample basis. A simple rule of thumb regarding reflections in the collinear arms is that they will never exceed the average reflection coefficient of the perpendicular arms. Thus, a tee which has a maximum VSWR of 1.10 in the H arm and 1.15 in the E arm, will have reflection coefficients of .05 and .07 respectively. The average reflection coefficient is .06. This means that the maximum VSWR of the collinear arms is $1 + .06 / 1 - .06 \approx 1.12$

Using the same sample, the isolation between collinear ports will have a voltage ratio no greater than .06 or approximately 25 db. In no case will the highest theoretical VSWR occur simultaneously with the lowest theoretical isolation. MDL tees are guaranteed to equal or exceed stated specifications. Typical wide-band performance curves are available.

Licensed H.A.C. pat. 2,840,787

H Plane Folded Hybrid Tees

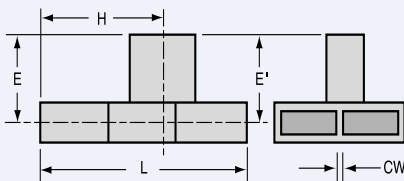
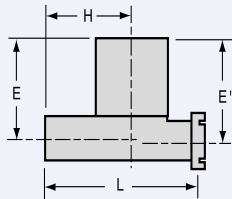
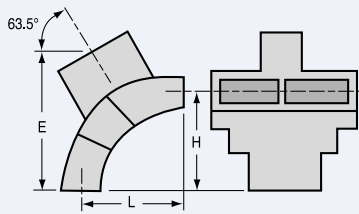

W/G Size	Electrical Data										Mechanical Data			
	Frequency GHz	Model Number	*VSWR Maximum		Isolation DB Min Between			Dimensions (inches)			Common Wall Thickness (inches)	Terminations		Recommended Dual Flange ¹²
			H Arm	E Arm	E & H Arms	Parallel Arms	Unbalanced DB Max.	L	E	H		E & H Arms	Parallel Arms	
WR10	91.75-95.75	10TH16 ²	1.25	1.25	34	19	.25	1.12	0.38	0.56	.040	Cover ¹⁶ Flange	50FS12	10FS12
WR15	50.0-60.0	15TH26 ²	1.30	1.30	35	18	.25	1.00	0.56	0.50	.040	UG385/U	15FS52	15FS52
	67.0-73.0	15TH16 ²	1.30	1.30	35	18	.25							
WR22	43.5-45.5	22TH12	1.15	1.15	40	-	.20	1.04	0.60	0.60	.040	WG	CORRAL	-
WR28	29.0-33.2	28TH42	1.25	1.25	35	22	.25	0.97	0.72	0.48	.040	WG	CORRAL	28FS12
	33.0-39.5	28TH22	1.35	1.35	35	22	.25							
	34.0-36.0	28TH12	1.20	1.20	35	22	.25							
WR42	20.2-21.2	42TH22	1.20	1.20	40	20	.15	1.26	0.71	0.71	.090	WG	CORRAL	42FS32
	22.5-26.0	42TH12	1.15	1.20	35	25	.10	0.95	0.76	0.48	.090	WG	CORRAL	42FS32
WR51	16.0-17.0	51TH22	1.12	1.15	40	28	.10	1.00	0.92	0.66	.040	WG	CORRAL	51FS12 ³
	16.50-19.65	51TH12	1.15	1.15	40	28	.10	1.39	0.92	0.80	.040	WG	CORRAL	51FS12 ³
WR62	12.4-14.5	62TH32	1.10	1.10	40	28	.10	1.75	0.92	0.91	.040	WG	CORRAL	62FS52
	14.5-15.0	62TH32	1.15	1.15	40	25	.10							
	13.5-15.6	62TH12	1.12	1.10	40	28	.10	1.61	0.91	0.92	.040	WG	CORRAL	62FS52 ³
	15.0-17.5	62TH22	1.12	1.10	40	28	.10	1.81	0.81	0.95	.090	WG	CORRAL	62FS92
	15.5-17.0	62TH42	1.08	1.10	40	30	.10							
WR75	10.5-11.7	75TH12	1.10	1.10	40	28	.10	1.77	0.92	0.80	.050	WG	CORRAL	75FS12
	11.0-12.85	75TH22	1.15	1.15	40	25	.10	1.96	1.09	1.10	.050	WG	CORRAL	75FS12
WR90	8.2-10.0	90TH32	1.15	1.25	40	24	.10	2.78	1.75	1.50	.120	WG	CORRAL	90FS112
	8.5-9.6	90TH32	1.10	1.12	40	28	.10							
	8.5-9.6	90TH52	1.12	1.20	40	24	.10	1.47	1.12	0.75	.050	WG	CORRAL	90FS82 ³
	8.5-9.6	90TH12	1.10	1.10	40	28	.10	2.22	1.75	1.50	.050	WG	CORRAL	90FS82 ³
	8.5-9.6	90TH42	1.06	1.10	45	32	.10	2.78	1.75	1.50	.120	WG	CORRAL	90FS112 ³
	8.65-11.0	90TH62	1.25	1.25	40	20	.10	2.53	1.75	1.50	.120	WG	CORRAL	90FS112 ³
	8.8-11.2	90TH72	1.25	1.25	30	18	.10	1.27	1.12	0.82	.050 ¹³	COR.	CORRAL	NONE
	9.2-10.0	90TH72	1.15	1.15	35	25	.10							
	10.2-12.4	90TH102	1.20	1.15	40	28	.10	2.18	1.18	1.20	.120	WG	CORRAL	90FS112
WR90 tapered to WR112	8.5-9.6	90TH22	1.10	1.10	40	28	.10	2.41	E=1.25 E'=1.30	1.50	.120	WR112 WG	WR90 CORRAL	90FS122
WR90 200 Hgt.	9.0-10.8	A90TH12	1.10	1.10	40	28	.10	2.00	0.98	1.10	.050	WG	CORRAL	
WR102	9.5-10.5	102TH12	1.10	1.10	40	28	.10	2.75	1.75	1.56	.150	WG	CORRAL	

Notes: *All tees exhibit reasonable electrical characteristics over a broader frequency range than specified. Maximum VSWR's specified does not indicate typical performance but only the highest VSWR over the operating range of the tee.

² Available only in copper alloy with flanges.

³ This flange is integral cast to the tee.

⁷ Add 0.17 to Dimension "L" when using recommended dual flange.

⁸ E=E' and H=H' unless otherwise shown.

⁹ Available only in non-brazable aluminum with flanges.

¹⁰ Available only in aluminum with flanges.

¹² SEE FOOTNOTE ON NEXT PAGE

¹³ No physical commonwall. 0.050 commonwall required by mating component to function electrically.

¹⁵ No physical commonwall. 0.160 commonwall required by mating component to function electrically.

¹⁶ Similar to UG387/U

H Plane Folded Hybrid Tees

H PLANE FOLDED HYBRID TEES

W/G Size	Electrical Data										Mechanical Data				
	Frequency GHz	Model Number	*VSWR Maximum		Isolation DB Min Between	E & H Arms	Parallel Arms	Unbalance DB Max.	Dimensions (inches)			Common Wall Thickness (inches)	Terminations		Recommended Dual Flange 12
			H Arm	E Arm					L	E	H		E & H Arms	Parallel Arms	
WR112	7.0-8.75	112TH32	1.25	1.25	40	20	.10	2.87	1.44	1.56	.150	WG	CORRAL	112FS82 ³	
	7.5-8.5	112TH42	1.10	1.10	40	28	.10								
	7.8-9.6	112TH82	1.25	1.50	40	20	.10	2.75	1.25	1.56	.150	WG	CORRAL	112FS82 ³	
	8.25-10.25	112TH62	1.15	1.15	40	25	.10	2.75	1.25	1.56	.150	WG	CORRAL	112FS82 ³	
	8.5-9.6	112TH72	1.10	1.15	40	25	.10								
	8.5-9.6	112TH52	1.10	1.10	40	30	.10	2.75	1.25	1.56	.064	WG	CORRAL	112FS62 ³	
	8.5-9.6	112TH12	1.08	1.10	40	30	.10	2.75	1.25	1.56	.150	WG	CORRAL	112FS82 ³	
WR137	5.4-5.9	137TH62	1.10	1.10	40	28	.10	4.11	2.15	1.95	.150	WG	CORRAL	137FS32 ³	
	5.9-6.5	137TH22	1.10	1.10	40	28	.10	3.81	1.75	2.25	.150	WG	CORRAL	137FS32 ³	
	6.0-7.0	137TH32	1.10	1.10	40	28	.10	3.81	1.56	2.25	.150	WG	CORRAL	137FS32 ³	
	6.6-8.2	137TH42	1.15	1.15	40	25	.10								
	6.8-8.0	137TH72	1.10	1.10	40	28	.10								
WR137 tapered to WR187	5.4-5.9	137TH12	1.08	1.08	40	30	.10	4.34	E=1.44 E'=1.56	2.37	.150	WR187 WG	WR137 CORRAL	137FS42	
A137 tapered to WR137	5.4-5.9	A137TH12	1.15	1.15	35	25	.10	3.50	E=1.65 E'=1.84	2.23	.150	WR137 WG	A137 CORRAL	FLANGE BLANK 3.56 x .87	
WR159	5.4-5.9	159TH12	1.10	1.10	40	28	.10	3.98	2.18	2.15	.150	WG	CORRAL	NONE	
	5.9-6.5	159TH22	1.10	1.15	40	26	.10	4.49	2.26	2.45	.150	WG	CORRAL	NONE	
WR187	3.95-4.4	187TH42	1.10	1.10	40	28	.10	4.44	1.62	2.62	.150	WG	CORRAL	187FS32 ³	
	4.4-5.0	187TH32	1.10	1.10	40	28	.10	4.41	2.23	2.34	.150	WG	CORRAL	187FS32 ³	
	5.0-6.0	187TH22	1.10	1.15	40	28	.10	3.97	2.37	2.00	.128	WG	CORRAL	187FS12	
	5.1-5.9	187TH12	1.10	1.10	40	28	.10								
WR229	3.7-4.2	229TH12	1.10	1.10	40	28	.10	5.64	2.92	3.03	.128	WG	CORRAL	FLANGE BLANK 6.21 x 2.42	
WR284	2.6-3.2	284TH12	1.15	1.15	40	25	.10	6.09 ⁷	2.62	3.55	.160	WG	CORRAL	284FS12	
	2.7-3.15	284TH22	1.10	1.10	40	28	.10								
	2.9-3.5	284TH42	1.18	1.12	40	25	.15	6.09	2.62	3.55	.160	WG	CORRAL	284FS12	
	3.0-3.4	284TH52	1.10	1.10	40	28	.15	6.09	2.62	3.55	.160	WG	CORRAL	284FS12	

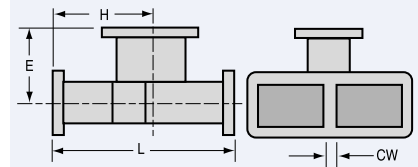
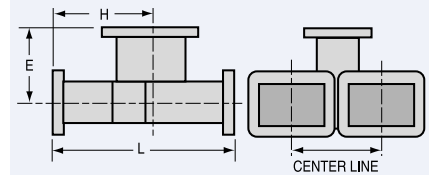

Notes: ³ This flange is integral cast to the tee.

12

- | | | |
|--|---------------------------------|------------------------------------|
| 10FS12 – Six 4-40 thread holes | 62FS92 – Four 0.144 dia. holes | 137FS32 – Ten 0.199 dia. holes |
| 15FS52 – Two 0.0630-0.0635 dia. holes, and Six 4-40 thread holes | 75FS12 – Four 0.125 dia. holes | 137FS42 – Ten 10-24 thread holes |
| 28FS12 – Six 0.116 dia. holes | 90FS82 – Six 8.32 thread holes | 187FS12 – Twelve 0.196 dia. holes |
| 42FS32 – Four 0.166 dia. holes | 90FS112 – Six 0.169 dia. holes | 187FS32 – Twelve 0.196 dia. holes |
| 51FS12 – Four 0.144 dia. holes | 90FS122 – Six 8.32 thread holes | 284FS12 – Twelve 0.261 dia. holes |
| 62FS52 – Four 0.144 dia. holes | 112FS62 – Ten 0.169 dia. holes | A284FS12 – Twelve 0.147 dia. holes |
| | 112FS82 – Ten 0.169 dia. holes | |

E Plane Folded Hybrid Tees

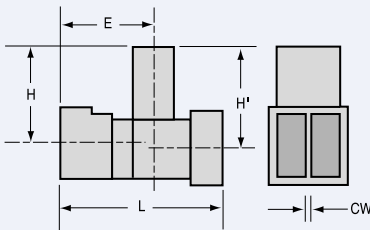
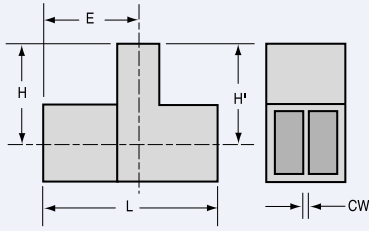

W/G Size	Electrical Data										Mechanical Data			
	Frequency GHz	Model Number	*VSWR Maximum		Isolation DB Min Between			Dimensions (inches)			Common Wall Thickness (inches)	Terminations		Recommended Dual Flange ¹²
			H Arm	E Arm	E & H Arms	Parallel Arms	Unbalanced DB Max.	L	E	H		E & H Arms	Parallel Arms	
WR28	28.0-29.0	28TE12	1.80	1.40	35	15	.25	0.90	0.49	0.68	.040	WG	CORRAL	28FT12 ³
	29.0-40.0	28TE12	1.50	1.35	35	18	.25							
	30.0-35.0	28TE32	1.25	1.25	35	20	.25	0.90	0.49	0.68	.040	WG	CORRAL	28FT12 ³
	34.0-38.0	28TE22	1.25	1.20	35	22	.25	0.90	0.49	0.60	.040	WG	CORRAL	28FT12 ³
WR42	19.5-27.0	42TE12	1.80	1.35	35	15	.20	1.14 ⁴	0.72	0.98	.040	WG	CORRAL	42FT12
	20.0-24.0	42TE22	1.20	1.15	35	22	.20							
WR51	15.2-17.2	51TE22	1.15	1.15	35	25	.10	1.04	0.66	1.04	.040	WG	CORRAL	51FT12
WR51 tapered to WR62	16.0-17.0	51TE12	1.15	1.15	35	25	.10	1.42	0.94	H=0.97 H'=1.03	.090	WR62 WG	WR51 CORRAL	51FT12
WR62	12.4-17.5	62TE72	2.20	1.30	35	15	.15	1.65	1.03	1.40	.090	WG	CORRAL	62FT12 ³
	14.0-15.0	62TE22	1.50	1.25	35	15	.15							
	15.0-18.0	62TE22	1.40	1.25	35	18	.15	1.65 ⁴	1.03	1.40	.090	WG	CORRAL	62FT12 ³
	15.0-17.0	62TE32	1.20	1.20	35	22	.15							
	16.0-17.0	62TE12	1.15	1.15	35	25	.10	1.87	0.94	0.97	.090	WG	CORRAL	62FT12 ³
WR75	10.5-14.9	75TE12	1.70	1.25	35	16	.15	1.92 ⁴	1.27	1.76	.090	WG	CORRAL	75FT12
	10.9-13.1	75TE22	1.15	1.20	35	20	.15							
WR90	7.5-8.3	90TE22	1.85	1.25	35	16	.10	1.94 ⁵	1.30	1.50	.120	WG	CORRAL	90FT12 ³
	8.3-10.7	90TE22	1.25	1.15	35	20	.10							
	10.7-10.95	90TE22	1.85	1.15	35	16	.10							
	8.2-12.4	90TE32	3.00	1.25	30	10	.10	2.23	1.30	1.50	.120	WG	CORRAL	90FT12 ³
	8.8-12.2	90TE32	2.00	1.25	35	15	.10							
WR90	8.5-9.6	90TE12	1.12	1.10	40	28	.10	1.94 ⁵	1.30	1.50	.120	WG	CORRAL	90FT12 ³
	9.0-10.25	90TE92	1.15	1.15	40	24	.10	1.94 ⁵	1.30	1.50	.120	WG	CORRAL	90FT12 ³
WR102	7.0-11.0	102TE12	1.80	1.15	40	18	.10	2.64	1.46	1.36	.150	WG	CORRAL	102FT12
WR112	7.5-8.5	112TE22	1.20	1.15	35	25	.10	2.33	1.50	2.00	.150	WG	CORRAL	112FT12 ³
	8.5-9.6	112TE32	1.15	1.12	40	25	.10	2.75	1.63	2.00	.150	WG	CORRAL	112FT12 ³
WR137	5.4-5.9	137TE12	1.10	1.10	40	28	.10	2.62	1.56	2.36	.150	WG	CORRAL	137FT12 ³
	5.4-6.8	137TE22	1.20	1.15	35	22	.10							
WR187	3.96-4.33	187TE22	1.10	1.10	40	28	.10	3.25	1.80	3.02	.150	WG	CORRAL	187FT12 ³
	5.4-5.9	187TE12	1.10	1.10	40	28	.10	4.00	2.23	2.56	.128	WG	CORRAL	187FT22 ³
WR229	3.7-4.2	229TE12 ¹³	1.15	1.10	40	25	.10	5.77	3.06	4.28	.150	WG	CORRAL	229FT12
WR284	2.6-3.0	284TE12	1.15	1.20	40	28	.10	4.64	2.97	4.67	.160	WG	CORRAL	284FT22
	2.9-3.5	284TE32	1.15	1.15	40	28	.10	4.64	2.97	4.67	.160	WG	CORRAL	284FT22

Notes: * All tees exhibit reasonable electrical characteristics over a broader frequency range than specified. Maximum VSWR's specified does not indicate typical performance but only the highest VSWR over the operating range of the tee.

³ This flange is integral cast to the tee.

⁴ Add 0.03 to Dimension "L" when using recommended dual flange.

⁵ Add 0.06 to Dimension "L" when using recommended dual flange.

⁸ E=E' and H=H' unless otherwise shown.

⁹ Available only in non-brazable aluminum with flanges.

¹²

28FT12 – Four 0.116 dia. holes

42FT12 – Four 0.116 dia. holes

51FT12 – Four 0.144 dia. holes

62FT12 – Four 0.144 dia. holes

75FT12 – Four 0.144 dia. holes

90FT12 – Four 0.169 dia. holes

102FT12 – Four 0.169 dia. holes

112FT12 – Four 8.32 thread holes

137FT12 – Four 0.219 dia. holes

187FT22 – Four 0.219 dia. holes

229FT12 – Eight 0.257 dia. holes

284FT22 – Eight 0.257 dia. holes

¹³ Fabricated unit sold only as a complete assembly.

Magic Tees

W/G Size	Figure	Frequency GHz	Electrical Data					Mechanical Data		
			Model Number ⁺	VSWR Maximum		Isolation DB Min Between E & H Arms	Unbalance DB	in inches		
				H Arm	E Arm			L	E	H
WR28	1A	29.0-34.0	28TN16	1.25	1.25	35	±.20	0.75	0.50	0.50
WR42	1A	20.0-24.0	42TN16	1.25	1.30	40	±.20	1.12	0.83	0.75
WR51	1A	15.8-17.5	51TN16	1.15	1.15	40	±.10	1.52	1.12	1.09
WR62	1A	15.4-17.2	62TN26	1.30	1.20	40	±.15	1.02	0.870	0.84
WR75	1A	10.35-12.35	75TN16	1.25	1.25	40	±.10	2.50	1.49	1.67
WR90	1A	8.5-9.6	90TN16	1.25	1.30	40	±.10	2.30	1.47	1.14
	1A	9.0-10.2	90TN26	1.15	1.15	40	±.10	2.30	1.47	1.14
	3	8.9-9.4	A90TN12 ^B	1.15	1.22	35	±.15	2.00	.70	1.00
	2	8.8-10.06	A90TN22 ^A FOLD E	1.35	1.35	30	±.25	1.96	.29	.68
	4	8.5-9.6	C90TN12 ^C	1.20	1.25	35	±.10	2.00	.56	.75
WR112	1B	8.5-9.6	112TN16 ^E	1.10	1.15	40	±.10	3.20	1.60	1.60
	1B	7.0-7.6	112TN26 ^E	1.35	1.25	40	±.10	3.20	1.60	1.60
WR137	1A	5.4-5.9	137TN16	1.15	1.10	40	±.10	3.62	1.90	1.90
	1A	5.9-6.5	137TN26	1.30	1.25	40	±.10	3.62	1.90	1.90
WR159	1A	5.1-5.95	159TN16	1.15	1.15	40	±.10	4.25	2.12	2.12
WR187	1A	5.4-5.9	187TN16	1.15	1.15	40	±.10	3.68	2.68	2.52
WR284	1A	2.9-3.5	284TN16 ^D	1.25	1.25	40	±.10	4.40	3.53	3.53
	1A	3.1-3.5	284TN26 ^D	1.15	1.20	40	±.10	4.40	3.53	3.53

Notes: ⁺ Model Numbers represent unit dimensions without flanges.
See page 46 for ordering information on flange combinations.

- ^A .200 Height.
- ^B .200 Height. E arm corral cast for .030 W/G wall.
- ^C .150 Height. Outputs corraled, E and H arms male W/G.
- ^D Supplied in Alum only.
- ^E Supplied with flanges only, per figure 1B.

1 = Supplied in figure 1A or 1B configuration.

MAGIC TEES

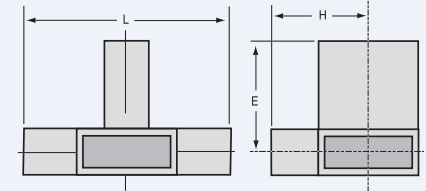

FIG. 1A (No Flanges)

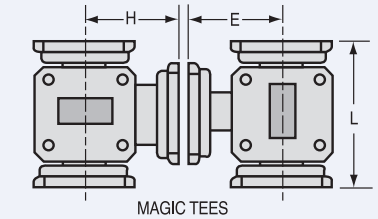

FIG. 1B (With Flanges)



FIG. 2

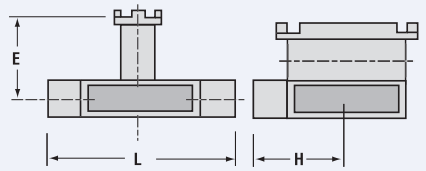

FIG. 3

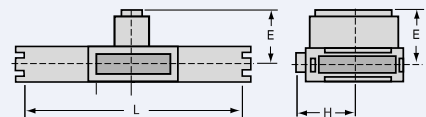
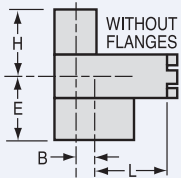
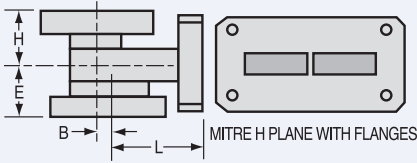

FIG. 4

Mitre H Plane Tees

MAGIC TEES



W/G Size	Electrical Data							Mechanical Data						
	Frequency GHz	Model Number	*VSWR Maximum		Isolation DB Min Between		Unbalance DB	Dimensions (inches)				Common Wall Thickness (inches)	Dual Output Terminal	Recommended Dual Flange ¹²
			H Arm	E Arm	E & H Arms	Parallel Arms		L	E	H	B			

Mitre H Plane with Flanges

WR28	33.5-36.0	28TC16	1.25	1.25	40	20	±10	.665	.310	.310	.070	.040	FLANGE	28FS12
	30.0-38.5	28TC26	1.50	1.50	40	10	±10	.665	.310	.310	.070	.040	FLANGE	28FS12
WR42	18.0-26.0	42CT16	1.70	1.50	40	10	±10	.610	.320	.320	.040	.040	FLANGE	42FS12
	16.0-17.0	51TC16	1.10	1.15	40	25	±10	.831	.388	.388	.128	.040	FLANGE	51FS12
WR51	15.5-18.0	51TC26	1.15	1.20	40	22	±10	.831	.388	.388	.128	.040	FLANGE	51FS12
	15.5-17.2	62TC16	1.15	1.15	40	23	±10	.835	.480	.361	.156	.040	FLANGE	62FS52
	15.0-17.5	62TC26	1.20	1.30	40	19	±10	.835	.840	.361	.156	.040	FLANGE	62FS52
	13.0-13.5	62TC36	1.20	1.20	40	23	±10	.835	.516	.516	.156	.040	FLANGE	62FS52
WR62	12.5-14.0	62TC46	1.35	1.18	40	19	±10	.835	.516	.516	.156	.040	FLANGE	62FS52
	8.5-9.6	90TC16	1.30	1.20	40	21	±10	.983	.410	.680	.250	.050	FLANGE	90FS72
	8.2-10.4	90TC26	1.45	1.40	40	15	±10	.983	.410	.680	.250	.050	FLANGE	90FS72
WR112	6.8-8.2	112TC16	1.30	1.30	40	17	±10	1.216	.620	1.041	.312	.064	FLANGE	112FS62
	6.5-8.5	112TC26	1.60	1.50	40	14	±10	1.216	.620	1.041	.312	.064	FLANGE	112FS62

Mitre H Plane Without Flanges

	Frequency GHz	Model Number	*VSWR Maximum	Isolation DB Min	Between	Unbalance DB	L		E		H		C/W	OUT TERM	B	
							STD.	MIN.	STD.	MIN.	STD.	MIN.				
WR28	33.5-36.0	28TC12	1.25	1.25	40	20	±10	.665	.213	.310	.236	.310	.150	.040	WG	.070
	30.0-38.5	28TC22	1.50	1.50	40	15	±10	.655	.213	.310	.236	.310	.150	.040	WG	.070
WR42	18.0-26.0	42TC12	1.70	1.50	40	10	±10	.610	.387	.320	.165	.320	.254	.040	WG	.125
	16.0-17.0	51TC12	1.10	1.15	40	25	±10	.335	.315	.388	.388	.388	.388	.040	CORRAL	.128
WR51	15.5-18.0	51TC22	1.15	1.20	40	23	±10	.335	.315	.388	.388	.388	.388	.040	CORRAL	.128
	15.5-17.2	62TC12	1.15	1.15	40	23	±10	.511	.427	.480	.480	.288	.361	.040	CORRAL	.156
WR62	15.0-17.5	62TC22	1.20	1.30	40	19	±10	.511	.427	.480	.480	.361	.288	.040	CORRAL	.156
	13.0-13.5	62TC32	1.20	1.20	40	23	±10	.361	.321	.361	.246	.361	.246	.040	CORRAL	.156
	12.5-14.0	62TC42	1.35	1.18	40	19	±10	.321	.361	.361	.246	.361	.246	.040	CORRAL	.156
	8.5-9.6	90TC12	1.30	1.20	40	21	±10	.983	.500	.410	.300	.680	.680	.050	CORRAL	.250
WR90	8.2-10.4	90TC22	1.45	1.40	40	15	±10	.983	.500	.410	.300	.680	.680	.050	CORRAL	.250
	6.8-8.2	112TC12	1.30	1.30	40	17	±10	1.070	.690	.450	.380	.950	.850	.064	WG	.312
WR112	6.5-8.5	112TC22	1.60	1.50	40	13	±10	1.070	.690	.450	.380	.950	.850	.064	WG	.312

Transducers

Dual mode transducers, capable of separating horizontal and vertical polarized waves, are readily available in most waveguide sizes. MDL's investment castings provide rigid, compact construction to insure precise mechanical configuration and excellent electrical performance. These designs feature low VSWR and insertion loss, high isolation and power handling capabilities.

Square output openings are standard except where noted. Circular outputs, other than those shown in the data below, and special flanges can be supplied upon request.

W/G Size	Frequency GHz	Style	Model Number	*VSWR Maximum		Mechanical Dimensions†			Output Dimensions		
				H Arm	E Arm	H	E	L	A	B	
Dual Mode Transducers											
WR22	35.5-37.5	1	22TR12	1.25	1.25	0.35	0.35	0.55	0.220	0.252	+0.03 -0.00
WR28	34.0-36.0	1	28TR12	1.20	1.20	0.50	0.43	0.81	0.204	0.286	+0.02 -0.00
WR42	19.5-23.0	1	42TR12	1.30	1.20	0.75	0.60	1.50	0.340	0.425	+0.03 -0.00
WR51	16.0-17.0	1	51TR12	1.15	1.15	1.00	0.79	1.50	0.454	0.536	+0.03 -0.00
	15.65-17.1	2	51TR22	1.15	1.20	0.75	1.20	1.32	0.600	0.500	±0.05
WR62	13.0-14.0	1	62TR22	1.15	1.15	1.10	0.95	1.80	0.562	0.645	+0.03 -0.00
	14.0-15.0	1	62TR32	1.12	1.12	1.10	0.85	1.80	0.519	0.599	+0.03 -0.00
	15.0-17.0	1	62TR12	1.15	1.15	1.10	0.95	1.80	0.454	0.536	+0.03 -0.00
WR75	10.8-11.5	1	75TR12	1.15	1.10	1.28	1.15	1.98	0.678	0.780	+0.03 -0.00
WR90	8.5-9.6	1	90TR12	1.10	1.10	1.75	1.35	2.50	0.800	0.905	+0.03 -0.00
	9.2-10.2	1	90TR22	1.25	1.25	1.75	1.35	2.50	0.800	0.905	+0.03 -0.00
WR112	7.0-8.0	1	112TR12	1.15	1.15	2.04	1.34	3.04	0.995	1.128	+0.04 -0.00
	7.0-8.0	2	112TR22	1.15	1.15	2.04	1.34	3.04	1.288	1.160	±0.05
	7.3-8.3	1	112TR32	1.55	1.45	2.04	1.34	3.04	0.995	1.128	+0.04 -0.00
WR137	5.4-5.9	1	137TR12	1.10	1.10	2.18	1.13	3.68	1.372	1.503	+0.05 -0.00
	5.4-5.9	1	137TR22	1.10	1.10	2.18	1.58	3.68	1.372	1.503	+0.05 -0.00
WR284	2.6-3.2	1	284TR32	1.50	1.15	4.16	3.30	6.63	2.525	2.690	+0.08 -0.00
	2.65-3.1	1	284TR12	1.20	1.15	4.16	3.30	6.63	2.525	2.690	+0.08 -0.00
	2.7-3.1	1	284TR22	1.15	1.12	4.16	3.30	6.63	2.525	2.690	+0.08 -0.00

Notes: Minimum isolation 40 db
 † Dimensional tolerances
 WR22 through WR137±.015
 WR284±.020

MITRE H PLANE TEES

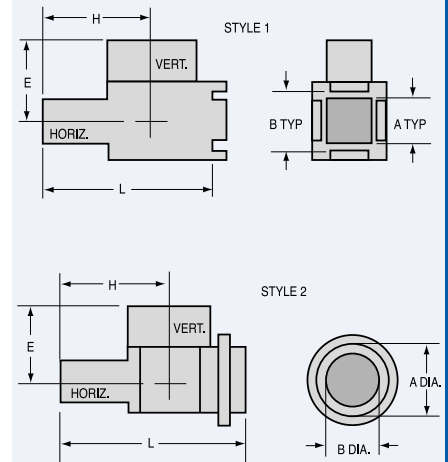

Transducers

TRANSDUCERS

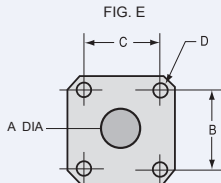
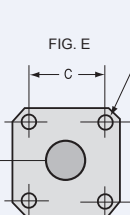
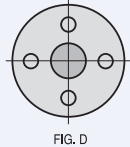
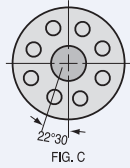
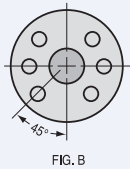
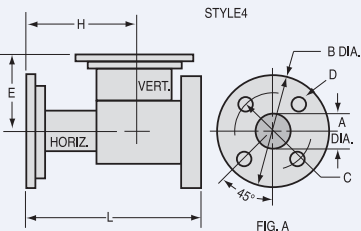
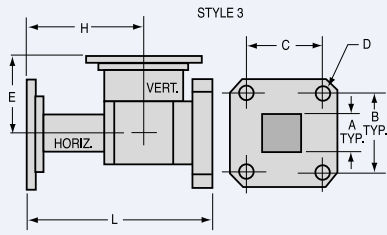

W/G Size	Frequency GHz	Style	Model Number	*VSWR Maximum		Mechanical Dimensions†						Flange pattern		
				H Arm	E Arm	H	E	L	A	B	C		D	
WR28	34.0-36.0	3	28TR16	1.20	1.20	0.50	0.54	0.81	.204	.500	.530	.116	-	
	34.0-36.0	4	28TR26	1.20	1.20	0.50	0.54	0.997	.238	.500	.530	THD	FIG. E	
WR42	19.5-23.0	4	42TR36	1.30	1.20	0.91	0.76	1.520	.400	1.135	.670	.116	FIG. A	
WR51	16.0-17.0	3	51TR16	1.15	1.15	1.00	1.10	1.50	.454	.956	.994	.144	-	
	15.65-17.1	4	51TR26	1.15	1.20	1.00	1.10	1.57	.500	1.350	.925	.144	FIG. A	
WR62	15.0-17.0	3	62TR16	1.15	1.15	1.10	1.18	1.80	.454	.956	.944	.144	-	
	13.0-14.0	3	62TR26	1.15	1.15	1.17	1.00	1.87	.562	.956	.994	.144	-	
	14.0-15.0	3	62TR36	1.12	1.12	1.10	0.95	1.68	.519	.956	.994	.144	-	
	13.75-15.25	4	62TR46	1.30	1.20	1.15	1.18	1.855	.590	1.300	1.000	6-32 THD	FIG. D	
	15.0-17.0	4	62TR56	1.20	1.20	1.10	1.18	1.80	.590	1.500	1.070	.144	FIG. A	
WR75	10.8-11.5	3	75TR16	1.15	1.10	1.28	1.15	1.98	.678	1.10	1.10	.144	-	
WR90	8.5-9.6	3	90TR36	1.10	1.10	1.75	1.35	2.50	.800	1.280	1.220	.169	-	
	9.2-10.2	3	90TR46	1.25	1.25	1.75	1.35	2.50	.800	1.280	1.220	.169	-	
	8.5-9.6	4	90TR56	1.25	1.25	1.75	1.35	2.500	.930	1.600	1.360	8-32 THD	FIG. D	
WR112	7.0-8.0	3	112TR16	1.15	1.15	2.04	1.34	3.04	.995	1.474	1.352	.169	-	
	7.2-7.8	4	112TR26	1.15	1.15	2.27	1.50	2.98	1.160	2.34	1.75	.169	FIG. B	
	7.3-8.3	3	112TR36	1.55	1.45	2.04	1.34	3.04	.995	1.474	1.352	.169	-	
	7.3-8.3	4	112TR46	1.55	1.45	2.27	1.50	2.98	1.160	2.34	1.76	.169	FIG. B	
WR137	5.4-5.9	3	137TR16	1.10	1.10	2.33	1.58	3.83	1.372	2.250	2.125	10.32 THD	-	
WR284	2.65-3.1	3	284TR16	1.20	1.15	4.16	3.30	6.63	2.525	8 HOLE FLANGE 284FT22		-	.257	-
	2.7-3.1	3	284TR26	1.15	1.12	4.16	3.30	6.63	2.525			-	.257	-
	2.6-3.2	3	284TR36	1.50	1.15	4.16	3.30	6.63	2.525			-	.257	-
	2.7-3.1	4	284TR46	1.20	1.17	4.16	3.30	7.75	2.940	6.50	-	.257	FIG. C	
	2.7-2.9	4	284TR56	1.20	1.20	4.16	3.30	7.75	2.940	6.50	-	.257	FIG. C	

Notes: Minimum isolation 40dB

*Dimensional tolerances WR22 through WR137±.015
WR284±.020

